



Magic Chef[™]
SO RIGHT AT HOME.[™]

Use & Care Manual

Auto Defrost Refrigerator

Model: MCBR510W

Structure Illustration.....	2
Important Safety Instructions.....	3
Installation Instructions.....	3
Operating Your Refrigerator.....	4-5
Freezer Compartment Operation....	5-6
Care & Maintenance.....	6
Changing the Reversible Door.....	7-8
Trouble Shooting Guide.....	9
Warranty.....	10

**READ AND FOLLOW THESE INSTRUCTIONS
BEFORE OPERATING THIS APPLIANCE.**

Structure Illustration

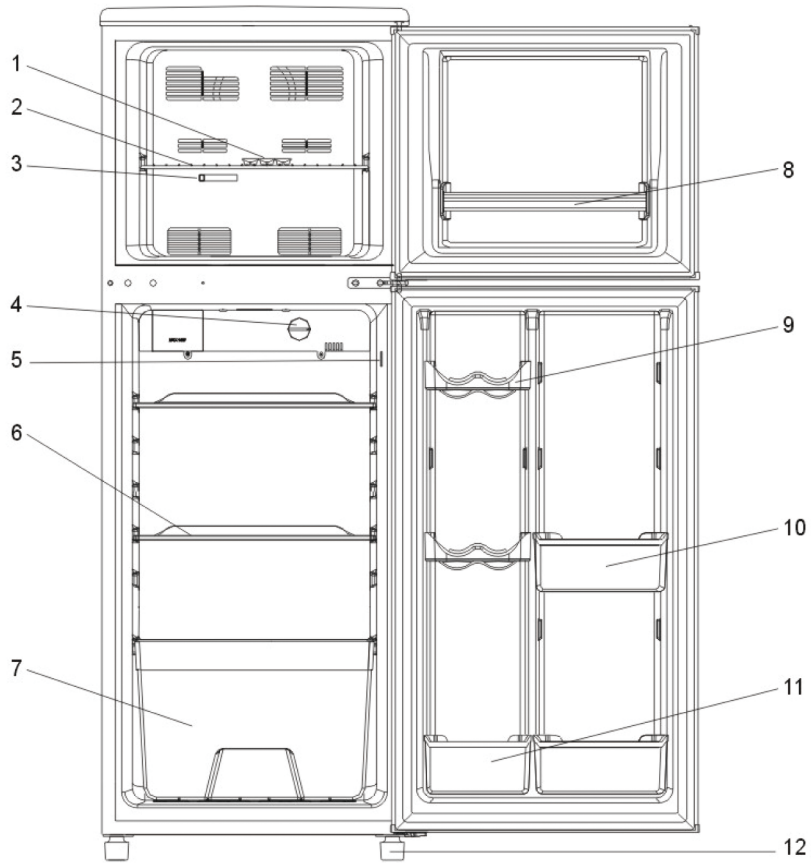

- 1. Ice-making tray
- 2. Freezer compartment shelf
- 3. Freezer temperature control knob
- 4. Refrigerator temperature control knob
- 5. Lamp switch
- 6. Refrigerator compartment shelf
- 7. Vegetable bin

- 8. Freezer door rail
- 9. Can rack
- 10. Bottle rack(long)
- 11. Bottle rack(short)
- 12. Adjustable feet

Important Safety Instructions



WARNING

To reduce the risk of fire, electrical shock, or injury follow these basic precautions when using your refrigerator.

- **DANGER:** Risk of child entrapment. To avoid the possibility of child entrapment, please take the following precautions before you throw out your refrigerator.
 - Remove all doors.
 - Leave shelves in place so children may not easily climb in.
 - Never allow children to play with, operate, or crawl inside the refrigerator.
- Do not store or use gasoline or any flammable vapors and liquids in the vicinity of this refrigerator.
- All refrigeration products contain refrigerants, which under the guidelines of federal law must be removed before disposal. It is the consumer's responsibility to comply with federal and local regulations when disposing of this product

Installation Instructions

Before Using Your Refrigerator

- Remove the exterior and interior packing.
- Before connecting the refrigerator to the power source, let it stand upright for approximately 4 hours. This will reduce the possibility of a malfunction in the cooling system from improper handling during transportation.
- Clean the interior surface with lukewarm water using a soft cloth. (Cleaning instruction on page 6.

Location

- Do not recess or build-in. This appliance is designed to be free standing only.
- Allow 5 inches clearance space between the back and sides of the refrigerator, which allows the proper air ventilation.
- **Avoid Installation:**
 - On weak surfaces unable to support refrigerator when fully loaded.
 - In direct sunlight and sources of heat (stove, heater, radiator, etc.). Ambient temperature below 50°F or above 85°F will hinder the performance of this appliance.
 - In moist areas.
 - In garage. **This unit is not designed for any type of outside installation.**
 - In moving vehicle. **This unit is not designed to be installed in an RV or used with an inverter.**

Installing Your Refrigerator

- Adjust the leveling feet to keep the refrigerator level.
- Plug the refrigerator into dedicated, properly installed-grounded wall outlet. Do not under any circumstances cut or remove the third (ground) prong from the power cord.
- After plugging the appliance into a wall outlet, turn the unit on and allow the unit to cool down for 2~3 hours under before placing food in the refrigerator or freezer compartment.

Electrical Connection



Improper use of the grounded plug can result in the risk of electrical shock. If the power cord is damaged, have it replaced by an authorized service center.

This refrigerator should be properly grounded for your safety. The power cord of this refrigerator is equipped with a three-prong plug which mates with standard three prong wall outlets to minimize the possibility of electrical shock.

Do not, under any circumstances, cut or remove the third ground prong from the power cord supplied.

This refrigerator requires a standard 115/120 Volt A.C. ~/60Hz electrical outlet with three-prong ground.

This refrigerator is not designed to be used with an inverter.

The cord should be secured behind the refrigerator and not left exposed or dangling to prevent accidental injury.

Never unplug the refrigerator by pulling the power cord. Always grip the plug firmly and pull straight out from the receptacle.

Do not use an extension cord with this appliance. If the power cord is too short, have a qualified electrician or service technician install an outlet near the appliance. Use of an extension cord can negatively affect the performance of the unit.

If any problems with the appliance persist, please contact our Customer Service Department to consult with a representative at **888 775-0202** or visit our website to request warranty service at **www.mcappliance.com**.

Operating Your Refrigerator

Temperature Control

- The temperature control is located on the top right hand corner of the fresh food compartment.
- The first time you turn the unit on, adjust the temperature control knob to “7” and run for at least 2 hours before putting food inside. This will ensure the cabinet is thoroughly chilled before food is inserted.
- The fresh food compartment temperature control ranges from the warmest position “1” to the coldest position “7”.
- Adjust the temperature control to the setting that best suits your needs. Moving the control to the “OFF” position stops cooling but does not shut off power to the refrigerator.

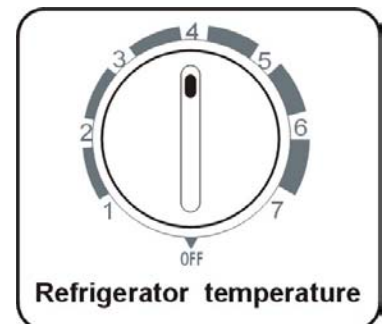

NOTE

If the unit is unplugged or loses power; you must wait 3 to 5 minutes before restarting the unit. If you attempt to restart before this time delay, the refrigerator may not start.

- Large amounts of food will lower the cooling efficiency of the appliance.
- Do not place the foods on the air outlet, and leave spaces for airflow.
- If you choose to change the thermostat setting, adjust thermostat control by one increment at a time. Allow several hours for temperature to stabilize between adjustments.

Changing the Light Bulb

Before removing the light bulb, turn off the refrigerator first. Then unplug the unit from the wall outlet. Failure to do so may result in electrical shock or personal injury.

1. Use a screwdriver to take out screw.
2. Remove the light cover by pulling downwards gently
3. Unscrew the bulb
4. Replace with a 15 watt-refrigerator bulb that is the same shape and size.
5. Replace the light bulb cover and tighten screw.

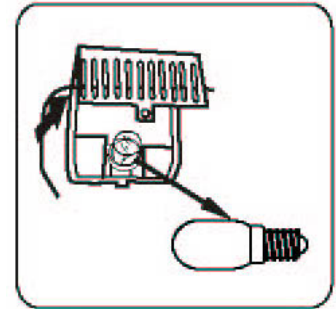

Freezer Compartment Operation

Temperature Control

- Your refrigerator has one control for regulating the temperature in the freezer compartment. The temperature control is located on the center of the freezer compartment's interior back panel.
- The first time you turn the unit on, adjust the temperature control knob to "MAX" and run for at least 2 hours before putting foods inside. This will ensure the cabinet is thoroughly chilled before food is put in.
- The range of the FREEZER temperature control is from position "MIN" the warmest to "MAX" the coldest. Adjust the temperature control to the setting that best suits your needs.

Freezer temperature

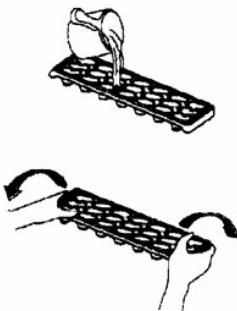
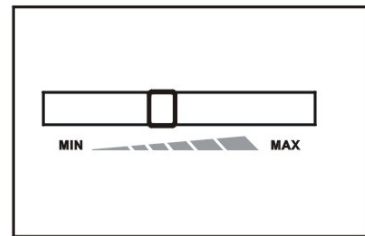

Ice Tray

To make ice, pour cool water into ice tray and place it in the freezer for two hours. To release ice cubes, twist the ice tray and the ice cubes will separate from the ice tray. To shorten the time of making ice, you can set the temperature control knob at a colder position.

NOTE

Do not store can foods or food stored in glass containers in the freezer compartment.

The Freezer Compartment

- This compartment is designed for the long-term storage of frozen food. The storage life of frozen foods varies and the recommended storage time should not be exceeded.
- Place frozen food into the freezer as quickly as possible after purchase. If there are instructions on the packet, carefully follow these instructions regarding storage times.

Care and Maintenance

Cleaning Your Refrigerator

- Upon installation of your new appliance, it is recommended that it be cleaned thoroughly.
- Turn the control to the OFF position and unplug the unit from the wall outlet.
- Clean interior and parts with a cloth soaked in lukewarm water and baking soda solution. A solution of 2 tablespoons baking soda to a quart of water will clean and neutralize odors. Rinse and wipe dry.
- Be sure to keep the door gasket (seal) clean to keep the unit running efficiently.
- The outside of the refrigerator should be cleaned with a warm damp cloth and mild detergent. Do not use harsh or abrasive cleaners.
- Never clean refrigerator parts with flammable fluids. The fumes can create a fire hazard.

Vacation Time

- For long vacations, remove all food and turn the control to the OFF position. Then, unplug the unit from the wall outlet.
- Clean the interior and leave doors open to avoid possible odor or mold formation.
- Use extreme caution in the case of children. The unit should not be accessible to child's play.

Moving Your Refrigerator









- Turn the control to the OFF position and unplug the unit from the wall outlet.
- Remove all the food and securely tape down all loose items such as shelves, drawers, and doors.
- Be sure the refrigerator stays in the upright position during transportation.

Energy Saving Tips

- The refrigerator should be located in the coolest area of the room, away from heat producing appliances or heating ducts, and out of the direct sunlight.
- Let hot foods cool to room temperature before placing in the refrigerator.
- Be sure to wrap foods properly, and wipe containers dry before placing them in the refrigerator. This cuts down on frost build-up inside the refrigerator.
- Organize and label food to reduce door openings and extended searches

Changing the Reversible Door

Your refrigerator is built with a reversible door. You have the choice of either opening it from the left or the right side. NOTE: Provide additional support for the doors while hinges are being removed. Do not depend on the door magnets to hold the door in place.

Door parts					
	axletree washer		right hinge		right bottom hinge
	mid hinge washer		left hinge		left bottom hinge
	mid hinge		Self-screw		

Step 1

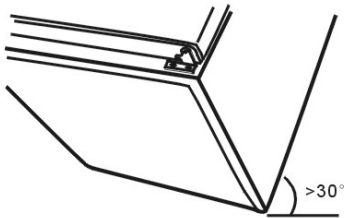

Have a second person help you tip the unit back to access the bottom hinge screw. Remove screws and bottom hinge.

Step 2

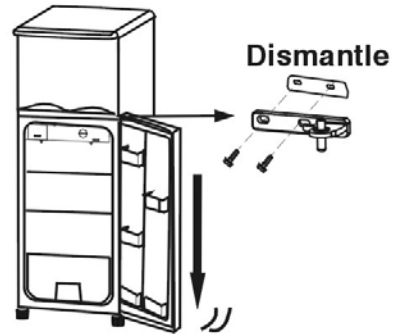

Carefully slide the door down off the middle hinge pin and set the refrigerator door aside. Remove screws holding on the middle hinge

Step 3

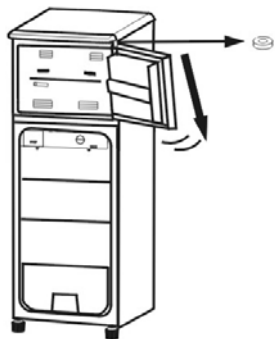

Carefully slide freezer door down off top hinge pin.

Step 4

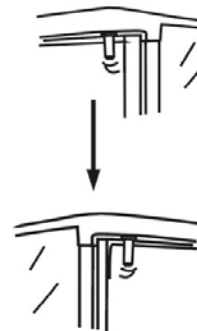

Unscrew the threaded top hinge pin and reattach on opposite side of the unit.

Step 5

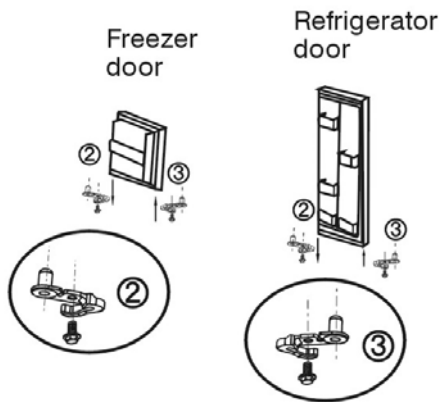

Remove Right side hinges from the bottom of the freezer and refrigerator doors. Replace both with Left side hinges.

Step 7

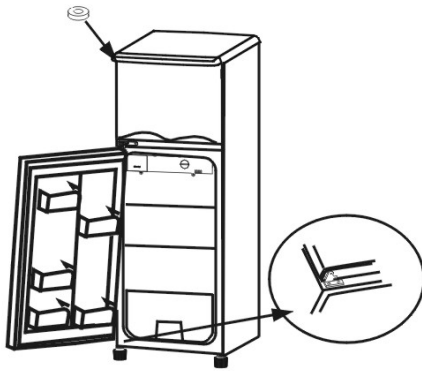

With help, insert the middle hinge pin into hole on the top of the refrigerator door. Insert the hinge pin from the bottom left hinge into the hole in the bottom of the refrigerator door, and screw hinge to main body of unit. Make sure refrigerator door lines up and closes tight, and then tighten screws for bottom and middle hinge

Step 6

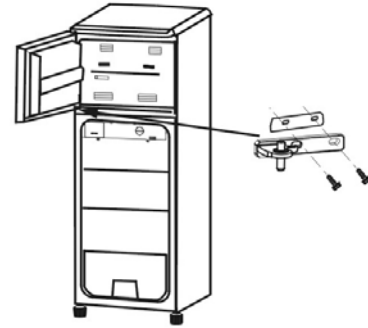

Insert washer on top hinge pin, and put freezer door on.

Turn the middle hinge over so that the upper and lower pins are on the left side, and attach on left side of refrigerator.

*Do not completely tighten the screws at this time.

Troubleshooting Guide

You can solve many common refrigerator problems easily, saving you the cost of a possible service call. Try the suggestions below to see if you can solve the problem before calling for service.

<i>Problem</i>	<i>Possible Causes</i>
Refrigerator does not operate	<ul style="list-style-type: none"> • Refrigerator is unplugged. • The circuit breaker is tripped/ fuse blown.
Compressor turns on and off	<ul style="list-style-type: none"> • The room temperature is warmer than normal • Door is left open or is frequently opened. • The refrigerator does not have the correct clearances. • The refrigerator has recently been disconnected for a period of time.
Refrigerator compartments are too warm	<ul style="list-style-type: none"> • Temperature control is not set correctly. • Door is left open or is frequently opened. • The door gasket does not seal properly. • A large amount of warm or hot food was stored recently. Wait for the refrigerator to reach its selected temperature. • The refrigerator has recently been disconnected for a period of time.
Vibrating or rattling (slight vibration is normal)	<ul style="list-style-type: none"> • Leveling legs need adjusting • Refrigerator is placed on an uneven or weak surface. • The refrigerator is touching the wall. Re-level the refrigerator and move it from the wall.
Temperature of external refrigerator surface is warm	<ul style="list-style-type: none"> • The exterior refrigerator walls can be as much as 30°F warmer than room temperature. • This is normal while the compressor works to transfer heat from inside the refrigerator cabinet.
Moisture collects inside the refrigerator	<ul style="list-style-type: none"> • Door is left open or is frequently opened.
Moisture forms on outside of refrigerator	<ul style="list-style-type: none"> • Is normal in hot and humid weather. Air carries moisture into the refrigerator when doors are opened.
Bubbling or gurgling sounds (like boiling water)	<ul style="list-style-type: none"> • This is the normal sound of refrigerant (used to cool refrigerator) circulating throughout the system.
Popping or cracking sounds when compressor comes on	<ul style="list-style-type: none"> • This is normal. Metal parts undergo expansion and contraction, like hot water pipes. The sound will level off or disappear as refrigerator runs.
The door will not close properly	<ul style="list-style-type: none"> • The refrigerator is not on a level surface. • The gasket is dirty. • The storage basket is out of position.



Refrigerator Warranty

MC Appliance Corporation warrants each new refrigerator to be free from defects in material and workmanship and agrees to remedy any such defect or to furnish a new part(s) (at the company's option) for any part(s) of the unit that has failed during the warranty period. Parts and labor expenses are covered on this unit for a period of one year after the date of purchase. In addition, **MC Appliance Corporation** warrants the compressor (parts only) to be free from defects in material and workmanship for a period of 5 years. The consumer is responsible for all labor and transportation expenses related to the diagnosis and replacement of the compressor after the initial one-year warranty expires. **A copy of the dated sales receipt / invoice is required to receive warranty service or a refund.**

This warranty covers appliances in use within the continental United States, Puerto Rico and Hawaii. The warranty does not cover the following:

- Damages due to shipping damage or improper installation.
- Damages due to misuse or abuse.
- Content losses due to failure of the unit.
- Inside components such as door panels, door shelves, racks, light bulbs, etc.
- Punctures to the evaporator system due to improper defrosting of the unit.
- Repairs performed by unauthorized service agents.
- Service calls that do not involve defects in material and workmanship such as instruction on proper use of the product, door reversal or improper installation.
- Replacement or resetting of house fuses or circuit breakers.
- Failure of this product if used for other than for its intended purpose.
- Disposal costs for any failed unit not returned to our factory.
- Any delivery costs incurred as the result of a unit that fails to perform as specified.

This warranty is in lieu of all warranties expressed or implied and no representative or person is authorized to assume for us any other liability in connection with the sale of this product. Under no circumstances is the consumer permitted to return this unit to the factory without prior written consent from **MC Appliance Corporation.**

Model	Parts & Labor	Compressor (Part Only)	Type of Service
MCBR510W	One-Year	Five -Years	Carry-In

For Service or Assistance please call **888 775-0202**. Or visit us on the web at www.mcappliance.com to request warranty service.