

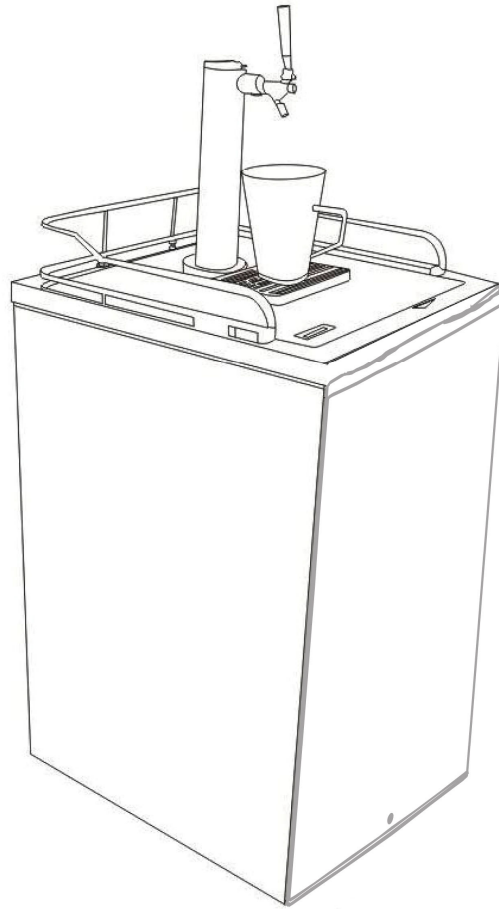

**4.9 CU.FT. BEER KEG COOLER
INSTRUCTION MANUAL**

Model No.: MCKC490B



To ensure proper use of this appliance and your safety, please read the following instructions completely before operating this appliance.

TABLE OF CONTENTS

Names of the Parts	3
Important Safety Instructions	4
Installation Instructions	4
Before Using Your Beer Dispenser	4
Installation of Your Beer Dispenser	4 - 5
Electrical Connection	5
Installation Instructions for Beer Keg	6 - 9
Dispensing of Beer	9
Operating Your Beer Dispenser	10
Setting the Temperature	10
Automatic Defrosting	10
Converting to an All Refrigerator	10
Changing the Reversible Door	11
Care and Maintenance	12
Troubleshooting Guide	12
Warranty	13

NAMES OF THE PARTS

MODEL NO.: MCKC490B

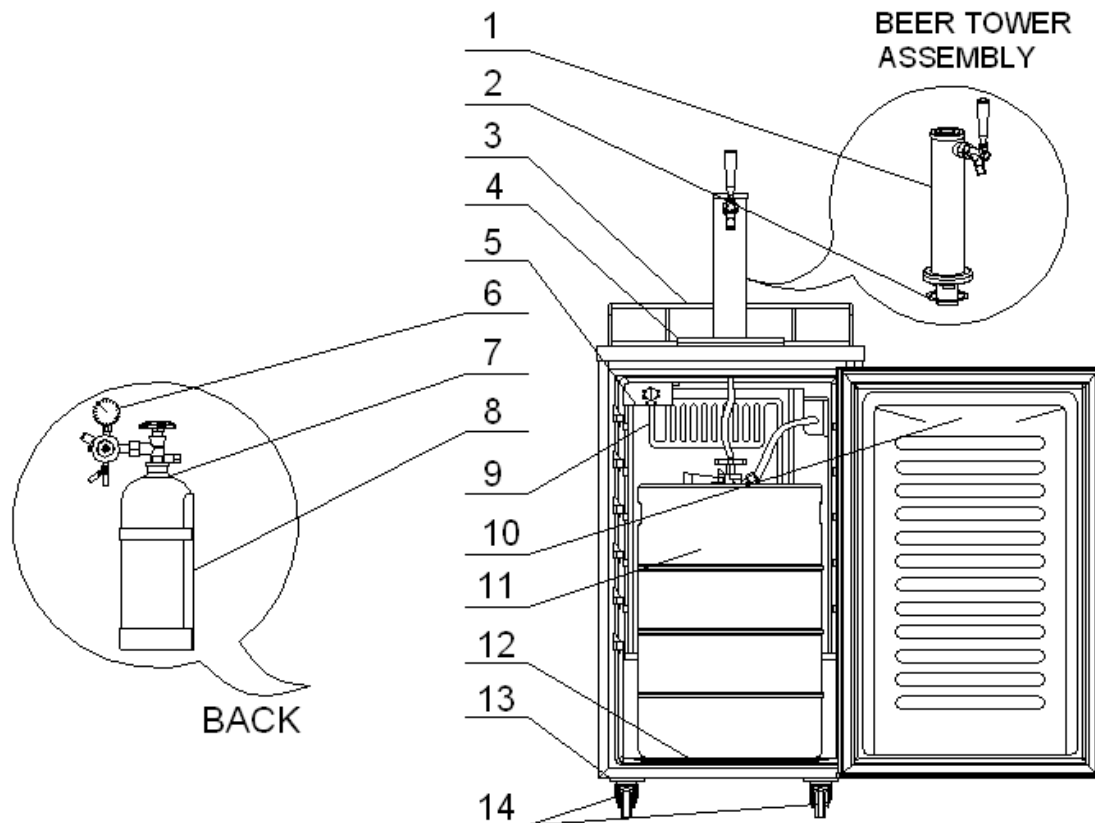

- 1 Beer Tower
- 2 Plastic Gasket
- 3 Safety Guard Rail
- 4 Drip Tray
- 5 Adjustable Thermostat
- 6 CO₂ Regulator
- 7 CO₂ Gas Cylinder
- 8 CO₂ Gas Cylinder Support
- 9 Evaporator
- 10 Reversible Door
- 11 Beer Keg (not included)
- 12 Metal Plate
- 13 Metal Washers(2)
- 14 Castors with Lock (4)

IMPORTANT SAFETY INSTRUCTIONS

⚡ WARNING ⚡	To reduce the risk of fire, electrical shock, or injury when using your Beer Dispenser, follow these basic precautions:
<ul style="list-style-type: none">• Read all instructions before using the unit.• WARNING: Risk of child entrapment.• To avoid the possibility of child entrapment, please take the following precautions before throwing out the appliance.<ul style="list-style-type: none">- Remove all doors from the unit.- Leave the shelves in place so that children may not easily climb inside.• Before you throw away your old unit: Take off the doors. Leave the shelves in place so that children may not easily climb inside.• Never allow children to operate, play with, or crawl inside the unit.• Refrigerants: All refrigeration products contain refrigerants, which under the guidelines of federal law must be removed before disposal of product. It is the consumer's responsibility to comply with federal and local regulations when disposing of this product.• Never clean unit parts with flammable fluids. The fumes can create a fire hazard or explosion.• Do not store or use gasoline or any other flammable vapors and liquids in the vicinity of this or any other unit. The fumes can create a fire hazard or explosion. <p style="text-align: center;">-Save these instructions-</p>	

INSTALLATION INSTRUCTIONS

➤ Before Using Your Beer Dispenser

- Remove the exterior and interior packing.
- Check to be sure you have all of the following parts:
 - 1 Safety Guard Rail
 - 1 Drip Tray (2 Pieces)
 - 1 CO₂ Cylinder Support
 - 1 CO₂ Regulator (Box)
 - 1 CO₂ Empty Cylinder(Box)
 - 1 CO₂ Air Line Hose (Red)
 - 1 Beer Keg Coupler (Box)
 - 1 Beer Tower
 - 1 Pull Handle (Beer Tower Faucet)
 - 1 Metal Wrench
 - 4 Plugs: For Guard Rail Holes
 - 1 Metal Plate For Cabinet Bottom
 - 2 Steel wire shelves
 - 1 Steel Clamp for Red Hose
 - 4 Castors with locks
 - 2 Metal Washers
- Before plugging in the keg cooler, let it stand upright for approximately 2 hours. This will reduce the possibility of a malfunction in the cooling system from handling during transportation.
- Clean the interior surface with lukewarm water using a soft cloth.

➤ Installation of Your Beer Dispenser

- This appliance is designed to be free standing only, and should not be recessed or built-in.
- Place your Beer Dispenser on a floor that is strong enough to support the Beer Dispenser when it is fully loaded.
- Allow 3 inches of space between the back and sides of the Beer Dispenser, which allows the proper air circulation to cool the compressor.
- Locate the Beer Dispenser away from direct sunlight and sources of heat (stove, heater,

radiator, etc.). Direct sunlight may affect the acrylic coating and heat sources may increase electrical consumption. Extreme cold ambient temperatures may also cause the Beer Dispenser not to perform properly. This unit is not designed for outside installation (ie garages, porches, etc.)

- Avoid locating the Beer Dispenser in excessive humidity.
- Plug the Beer Dispenser into a dedicated, properly installed-grounded wall outlet. Do not under any circumstances cut or remove the third (ground) prong from the power cord. Any questions concerning power and or grounding should be directed toward a certified electrician or an authorized service center.
- After plugging the appliance into a wall outlet, allow the unit to cool down for 2-3 hours before placing any contents in the Beer Dispenser compartment.

➤ **Electrical Connection**

⚡ Warning ⚡

Improper use of the grounded plug can result in the risk of electrical shock. If the power cord is damaged, have it replaced by an authorized service center.

This Beer Dispenser should be properly grounded for your safety. The power cord of this Beer Dispenser is equipped with a three-prong plug which mates with standard three prong wall outlets to minimize the possibility of electrical shock.

Do not under any circumstances cut or remove the third ground prong from the power cord supplied.

Use of extension cords is not recommended.

This Beer Dispenser requires a standard 115/120-volt, 60Hz electrical outlet with three-prong ground receptacle. The cord should be secured behind the Beer Dispenser and not left exposed or dangling to prevent accidental injury.

Never unplug the Beer Dispenser by pulling the power cord. Always grip the plug firmly and pull straight out from the receptacle.

**WARNING
CO₂ GAS CAN BE DANGEROUS**

WARNING: CO₂ cylinders contain high-pressure compressed gas which can be hazardous if not handled properly. Make sure you **READ** and **UNDERSTAND** the following procedures for CO₂ cylinders **BEFORE INSTALLATION**.

1. **ALWAYS** connect the CO₂ cylinder to a regulator. Failure to do so could result in explosion with possible injury when the cylinder valve is opened.
2. **NEVER** connect the CO₂ cylinder directly to the product container.
3. **ALWAYS** follow correct procedures when cylinders are changed.
4. **ALWAYS** secure the cylinder in an upright position.
5. **NEVER** drop or throw a CO₂ cylinder.
6. **ALWAYS** keep a CO₂ cylinder away from heat. Store extra cylinders in a cool place (preferably 70°F). Securely fasten with a chain in an upright position when storing.
7. **ALWAYS** ventilate and leave the area immediately if CO₂ leakage has occurred.
8. **ALWAYS** check the D.O.T. test date on the cylinder neck before installation. If over five (5) years, do not use, return cylinder to gas supplier.
9. **NEVER** connect a product container unless there are two (2) safety's in the pressure system:
 - a. One at or on the CO₂ regulator
 - b. One at or on the product coupler or in the pressure gas line.

INSTALLATION INSTRUCTIONS FOR BEER KEG

Keg Installation Sketch

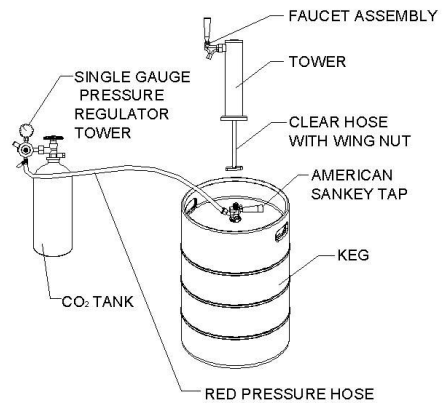

- Install the four castors with lock provided into the unit's bottom (four screw holes pre-supplied)
The two metal gaskets are used for the front two Castors. Figure (1) before installation. Figure (II) is the final version.

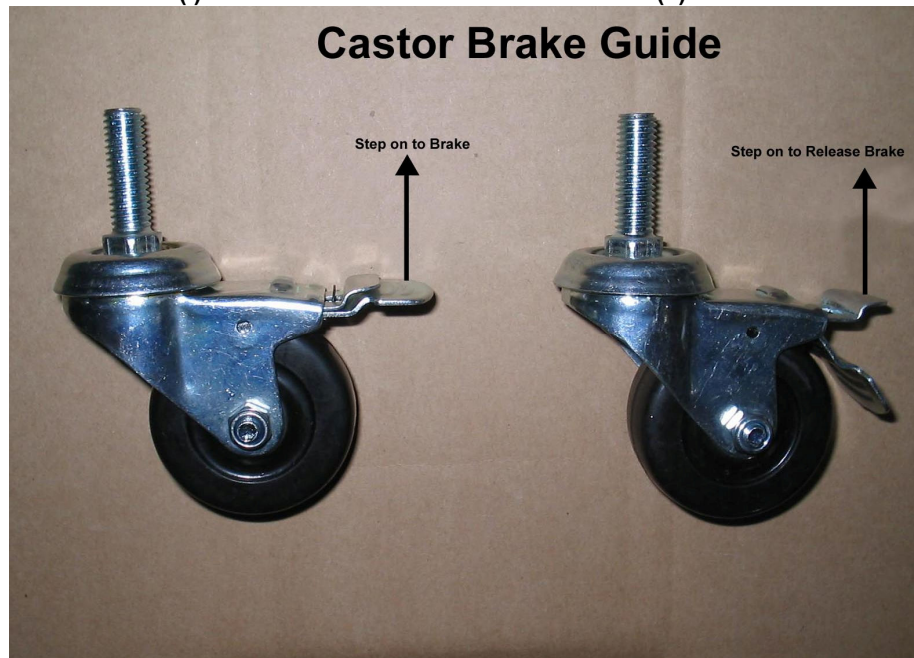
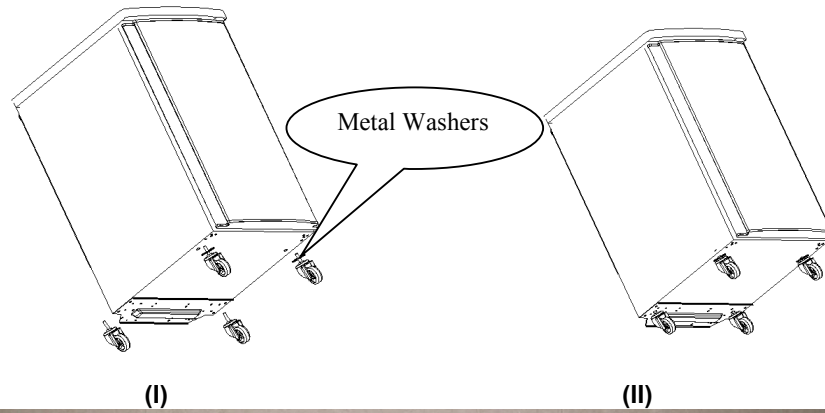

Installation Of CO₂ Cylinder Support

- Install the metal support provided onto the 4 studs located on the exterior back wall. Align the holes in the support with the studs and push down firmly. (See Figure 1)

Installation Of CO₂ Cylinder

- The CO₂ Cylinder does not come filled. The cylinder must be filled with CO₂ prior to use.
- Install your fully charged cylinder into the support stand

Installation Of CO₂ Regulator

- Attach the CO₂ regulator to the cylinder by turning the regulator nut onto cylinder valve, making sure washer is securely inserted into connecting nut. Tighten snug using an adjustable wrench (not supplied) and assure there are no leaks. (See Figure 2)



Fig. 1

Fig. 2

Fig. 3

Installation Of CO₂ Air Line Outside Cabinet

- Remove plug located at the exterior back (top left hand corner).
- Save it for later use if you decide to convert unit to a refrigerator.
- Insert the open end of the air line (red) line the cabinet through the uncovered hole. (See Figure 4)

Installation Of CO₂ Air Line Hose To Regulator

- Attach the open end of the red hose to the hose barb connection on the regulator
- Secure hose by using one clamp provided. Use pliers/screwdriver to tighten clamp to prevent leaks. (See Figure 3)

Installation Of The Beer Tower

- Remove the top plug by twisting and pulling out, saving it for later use if you decide to convert unit to an all refrigerator unit.
- Unravel the beer line (clear hose) from the tower and insert the beer line and wing nut through the uncovered hole on top.
- Lock the beer tower assembly to the top and make sure to position the beer faucet so it is aligned with the cabinet front (6 o'clock position). You accomplish this by aligning the bottom of the beer tower to the 3 grooves on the top cabinet and tighten by hand clockwise to properly lock.
- The plastic gasket (# 2 in parts list), can be used to make the connection between the tower and the cooler tighter if needed. If Beer Tower will not turn to lock in place, try removing the plastic gasket.

Installation Of Protective Metal Plate

- This plate should always be installed when the keg is in place to protect against unnecessary damage to the floor of the cabinet.

Installation Of The Beer Keg

- Position the beer keg directly in front of the open door. Using keg handles only, carefully lift the beer keg. (See Figure 5)
- To place the beer keg inside the cabinet, brace your knees behind the beer keg. Lift the front of the keg just enough so the front edge of the keg is resting on the front edge of the Beer Dispenser bottom cabinet. (See Figure 6)
- Grasp the keg handles and slide it all the way into the cabinet.

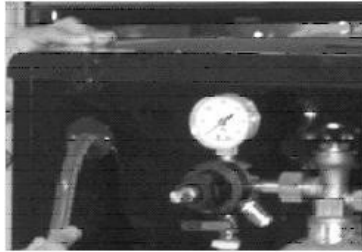

Fig. 4



Fig. 5



Fig. 6

Installation Of The Keg Coupler

- Insert the keg coupler provided into the locking neck of the beer keg and turn it clockwise to lock into position, making sure the keg coupler is in the closed position. (See Figure 7)

Installation Of The CO₂ Air Line Hose

- Attach the end of the air line (red) hose provided to the hose connection on the keg coupler.

Connecting the beer tower to coupler

- Make sure the washer is properly inserted into the wing nut.
- Make sure the small round bead is in place (dropped down into the top of the coupler).
- Make sure the ball retainer is in place on the coupler, with the 'arms' down into the coupler.
- Place wing nut into the top of the coupler turning until tight.

How to Tap a Keg of Beer

- Make sure that the CO₂ is turned off, and the Secondary valve on the regulator is in the 'Closed' position.
- Pull out and release the pressure release valve on the Coupler to purge any air pressure.
- Make sure the beer tower faucet is in the closed position.
- Pull tapping handle out and press downward until it locks into position. (See Figure 8) The keg is now tapped.

Opening the CO₂ Cylinder Main Valve

- Make sure the secondary shut-off valve (shown in figure 9 in 'Open' position) is closed. To open the main CO₂ cylinder valve, slowly turn the main valve counter-clockwise until fully open.
- Notice the needle on the regulator gauge start to climb.

Adjusting The CO₂ Regulator

The gauge monitors low internal keg pressure and should be adjusted to read between 10-12 psi. (See Figure 10). The pressure can be adjusted as needed.

- Release adjustment lock nut marked 2.
- Using a flat screwdriver, turn regulator screw marked 3.
 - To increase pressure, turn screw clockwise.
 - To decrease pressure, turn screw counter - clockwise.
- Retighten lock nut marked 2.
- Open secondary shut off valve to let CO₂ flow into the keg.
- Allow several minutes for the keg to properly pressurize. Regulator gauge may drop while this happens. (Note: Listen for hissing along all connections to identify if there are any leaks)

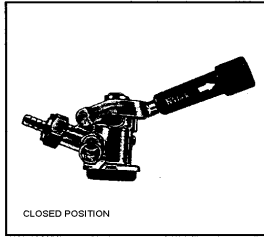

Fig. 7

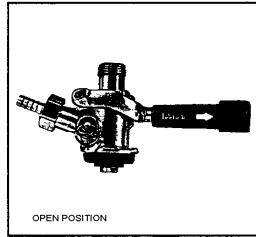

Fig. 8

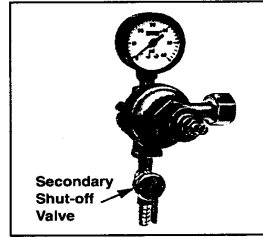

Fig. 9

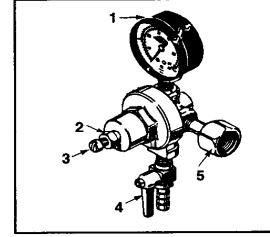

Fig. 10

➤ **Spanner Faucet Wrench**



Spanner faucet wrench is provided for either removing or tightening connection

➤ **Plastic Faucet Lever**



Attach the black plastic lever (pull handle) to the top of the faucet by tightening it by hand clockwise until the end, holding in the silver nut underneath so it does not turn. If there is still a small drip from the faucet, you may have tightened the plastic lever too much and may need to unscrew silver snug counter-clockwise (as shown) one turn.

DISPENSING OF BEER

- Keep beer keg refrigerated at all times.
- Never allow beer lines to dry out.
- Use clean beer glassware before pouring.
- Hold glass at a 45° angle when 2/3 full, start to straighten glass as the glass fills.
- Always make sure the faucet handle is pushed all the way back.

Note: Keg sizes that can be used in your beer dispenser

1/2 barrel	59 Liters	15.5 gals	1984 oz.	164/12-oz. Glass
1/4 barrel	30 Liters	7.8 gals.	992 oz.	82/12-oz. Glass
1/6 barrel	20 Liters	5.2 gals.	661 oz.	55/ 12-oz. Glass
1/8 barrel	15 Liters	4.0 gals.	496 oz.	41/ 12-oz. Glass

Note: Our Beer dispenser accepts standard kegs up to 16-1/8" in diameter, and up to 23-3/8" in height. Check with your distributor to make sure keg is correct size.

OPERATING YOUR BEER DISPENSER

➤ Setting The Temperature

To start, turn the temperature control knob to the maximum setting (6). Allow the unit to run for 24 hours for the unit to cool properly. You may then adjust the temperature to the desired setting.

In average room conditions of 70°F (21 °C), set thermostat knob position between “4” and “5”.

To turn off the Beer Dispenser, rotate the control knob to the “OFF” position.

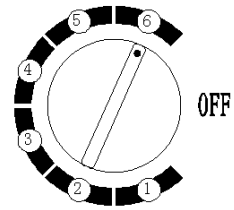

Note: To accurately measure the temperature of liquid in the unit, place a cup of water in the front corner, and place a liquid thermometer in the water.

During the summer when temperatures are warmer, we recommend that you adjust the control to a cooler setting.

The time it takes to reach your desired temperature depends on the beer keg size and the room conditions where the beer keg cooler is located. Normally, on setting of 6, it takes no more than 36 hours for a 1/2 barrel keg to cool down if the ambient temperature is 60°F to 75°F.

The more beer there is, the longer it will take to cool down.

Automatic Defrosting

There is no need to defrost the Beer Dispenser. Defrost water collects and passes thru the drain outlet in the rear wall into a tray located above the compressor, where it evaporates.

NOTE: If the unit is unplugged, power lost, or turned off; you must wait 3 to 5 minutes before restarting the unit. If you attempt to restart before this time delay, the Beer Dispenser may not start.

➤ Converting To An “All Refrigerator”

1. Turn off the control knob to the “OFF” position.
2. Close the main valve on the CO₂ cylinder.
3. Close the secondary shut-off valve on the regulator pipe.
4. Close the connection between the beer keg and the keg coupler.
5. Drain any remaining beer from the lines.
6. Disconnect the beer line and CO₂ air line from the keg coupler
7. Remove the beer keg.
8. Remove the keg coupler.
9. Disconnect the air line from the CO₂ cylinder.
10. Remove the CO₂ air line from cabinet plug
11. Replace the air line rear cabinet plug
12. Remove the beer tower. Also pull the beer line thru the top of the cabinet
13. Replace the top cabinet plug
14. Adjust temperature as desired.

CHANGING THE REVERSIBLE DOOR

This Beer Dispenser has a door that can be set to open from the left or right side. The unit is delivered to you with the door opening from the left side. To reverse the opening direction, please follow the instructions below.

Caution: To avoid personal injury to yourself and/or property, we recommend that someone assist you during the door reversal process.

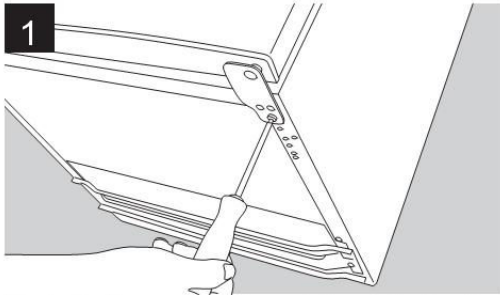

Undo the three screws in each bracket using the Phillips screwdriver.

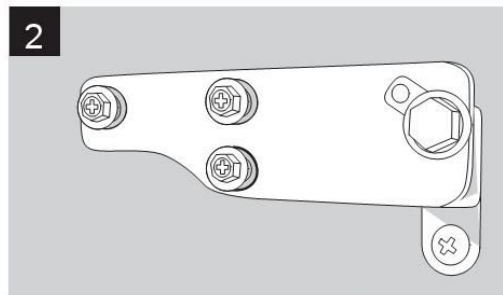

Remove the screws and bracket. Place to one side.

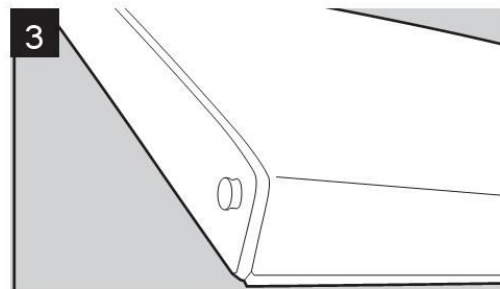

Slide the Larder Fridge door down about 15cm [6"] and off the top hinge pin and lift away from the Freezer.



Using the flat bladed screw driver remove the pin from the top bracket. Replace it in the hinge bracket on the opposite side.

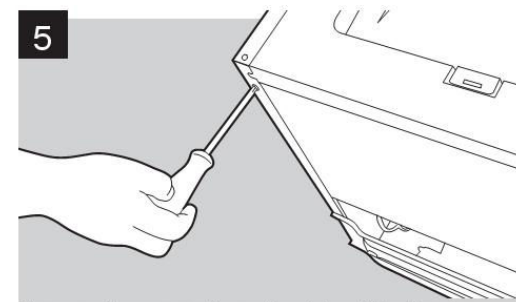

Remove the screw from the side of the Larder Fridge where the bracket is to be re-fitted and replace on the other side.

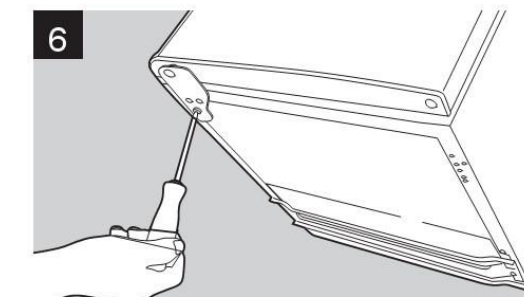

Slide the Larder Fridge door back on to the top hinge, making sure it's the right way up. Screw the bottom hinge into place on the new side.

7 Check that door is aligned horizontally and vertically and that the seals are closed on all sides before finally tightening the bottom hinge. Re-adjust the levelling feet.

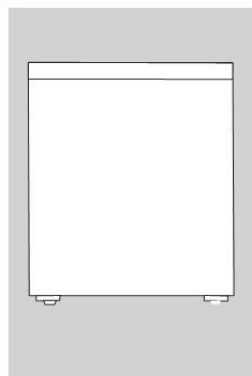

CARE AND MAINTENANCE

➤ Cleaning Your Beer Dispenser

- Turn the temperature control to "OFF", unplug the Beer Dispenser, and remove the contents.
- Wash the inside surfaces with a warm water and baking soda solution. The solution should be about 2 tablespoons of baking soda to a quart of water.
- Wash the shelves and stand with a mild detergent solution.
- Wipe down any electrical controls with a dry clothe.
- Wash the outside cabinet with warm water and mild liquid detergent. Rinse well and wipe dry with a clean soft cloth.

➤ Vacation Time

- **Short vacations:** Leave the Beer Dispenser operating during vacations of less than three weeks.
- **Long vacations:** If the appliance will not be used for several months, remove all contents and unplug the power cord. Clean and dry the interior thoroughly. To prevent odor and mold growth, leave the door open slightly.

➤ Moving Your Beer Dispenser

- Remove all the contents.
- Securely tape down all loose items inside your Beer Dispenser.
- Tape the door shut.
- Be sure the Beer Dispenser stays secure in the upright position during transportation. Also protect outside of Beer Dispenser with a blanket or similar item.

TROUBLESHOOTING GUIDE

You can solve many common Beer Dispenser problems easily, saving you the cost of a possible service call. Try the suggestions below to see if you can solve the problem before calling the servicer.

PROBLEM	POSSIBLE CAUSE
Beer Dispenser does not operate.	Not plugged in. The circuit breaker tripped or blown fuse.
Turns on and off frequently.	The room temperature is hotter than normal. The door is open too often. The door is not closed completely. The temperature control is not set correctly. The door gasket does not seal properly. The unit does not have proper clearance.
Vibrations.	Check to assure that the Beer Dispenser is level.
The Beer Dispenser seems to make too much noise.	The rattling noise may come from the flow of the refrigerant, which is normal. Gurgling, caused by liquid refrigerant cycling, is normal. Contraction and expansion of the inside walls may cause popping and crackling noises. The Beer Dispenser is not level.
The door will not close properly.	The Beer Dispenser is not level. The door was reversed and not properly installed. The gasket is dirty. The shelves or stand are out of position. The Keg is not properly centered in the unit. The Castors are not attached.



WARRANTY

MC Appliance Corporation warrants each new Beer Keg Cooler to be free from defects in material and workmanship and agrees to remedy any such defect or to furnish a new part(s) (at the company's option) for any part(s) of the unit that has failed during the warranty period. Parts and labor expenses are covered on this unit for a period of one year from the date of purchase. In addition, **MC Appliance Corporation** warrants the compressor (part only) to be free from defects in material and workmanship for a period of 5 years. The consumer is responsible for all labor and transportation expenses related to the diagnosis and replacement of the compressor after the initial one-year warranty expires. **A copy of the dated sales receipt / invoice is required to receive warranty service or a refund.**

This warranty covers appliances in use within the continental United States, Puerto Rico and Hawaii. The warranty does not cover the following:

- Damages due to shipping damage or improper installation.
- Damages due to misuse or abuse.
- Content losses due to failure of the unit.
- Inside components such as door panels, door shelves, racks, light bulbs, etc.
- Punctures to the evaporator system due to improper defrosting of the unit.
- Repairs performed by unauthorized service agents.
- Service calls that do not involve defects in material and workmanship such as instruction on proper use of the product, door reversal or improper installation.
- Replacement or resetting of house fuses or circuit breakers.
- Failure of this product if used for other than for its intended purpose.
- Disposal costs for any failed unit not returned to our factory.
- Any delivery costs incurred as the result of a unit that fails to perform as specified.
- Expenses for travel and transportation for product service if your appliance is located in a remote area where service by an authorized service technician is not available.
- The removal and reinstallation of your appliance if it is installed in an inaccessible location or is not installed in accordance with published installation instructions.

This warranty is in lieu of all warranties expressed or implied and no representative or person is authorized to assume for us any other liability in connection with the sale of this product. Under no circumstances is the consumer permitted to return this unit to the factory without prior written consent from **MC Appliance Corporation.**

Model	Parts	Labor	Compressor (Part Only)	Type of Service
MCKC490B	One-Year	One-Year	Five Years	In-Home

For Service or Assistance please call **888 775-0202**. Or visit us on the web at www.mcappliance.com to request warranty service or order parts.